

Flow Measurement

SITRANS F C

Flow sensor MASS 2100 DI 3 to DI 40

Overview



MASS 2100 DI 3 to DI 40 is suitable for accurate mass flow measurement of a variety of liquids and gases.

The sensor offers superior performance in terms of flow accuracy, turn-down ratio and density accuracy. The ease of installation through a "plug & play" mechanical and electrical interface ensures optimum performance and operation.

The sensor delivers true multi-parameter measurements i.e.: Mass flow, volume flow, density, temperature and fraction.

Benefits

- High accuracy better than 0.1% of mass flow rate
- Large dynamic turn-down ratio better than 500:1
- Densitometer performance available through a density accuracy better than 0.0005 g/cm^3 with a repeatability better than 0.0001 g/cm^3
- Single continuous tube design, with no internal welds, reductions or flow splitters offers optimal hygiene, safety and CIP cleanability for food and beverage and pharmaceutical applications.
- Markets' biggest wall thickness, ensuring optimal life-time and corrosion resistance and high-pressure durability
- Full bore design provides lower pressure loss due to same internal diameter throughout the entire sensor.
- Balanced pipe design with little mechanical energy loss, ensures optimal performance and stability under non-ideal and unstable process conditions (pressure, temperature, density changes etc.).
- 4-wire Pt1000 temperature measurement ensures optimum accuracy on mass flow, density and fraction flow.
- Multi-plug electrical connector and SENSORPROM enables true "plug & play". Installation and commissioning in less than 10 minutes.
- Intrinsically safe Ex design ia IIC as standard, making service in hazardous area possible without having to demount the sensor if a compact Ex d transmitter needs service.
- Sensor pipe available in high-quality AISI 316L stainless steel mat. no 1.4435 or Hastelloy C22 mat. no 2.4602 offering optimum corrosion resistance
- Centre-block design decouples process noise from the environment such as vibrations, pulsations, pressure shocks etc. making installation flexible and versatile.
- Rugged and space-saving sensor design in stainless steel matching all environments
- High-pressure program as standard
- The sensor calibration factor is also valid for gas measurement.
- Uniform sensor interface matching all transmitter versions at the same time whether it is compact IP67/NEMA 4X, compact Ex d or remote installation, one sensor fits all.

Application

Coriolis mass flowmeters are suitable for measuring all liquids and gases. The measurement is independent of changes in process conditions/parameters such as temperature, density, pressure, viscosity, conductivity and flow profile.

Due to this versatility the meter is easy to install and the Coriolis flowmeter is recognized for its high accuracy in a wide turn-down ratio which is a paramount in many applications.

The main applications of the Coriolis flowmeter can be found in all industries, such as:

Chemical and pharma	Detergents, bulk chemicals, pharmaceuticals, acids, alkalis
Food and beverage	Dairy products, beer, wine, soft-drinks, BRIX/PLATO, fruit juices and pulps, bottling, CO ₂ dosing, CIP-liquids
Automotive	Fuel injection nozzle and pump testing, filling of AC units, engine consumption, paint robots
Oil and gas	Filling of gas bottles, furnace control, CNG-dispensers, test separators, LPG
Water and waste water	Dosing of chemicals for water treatment

The wide variety of combinations and versions from the modular system means that ideal adaptation is possible to each measuring task.

Design

The MASS 2100 sensor consists of a single bent tube in a double bent pipe configuration, welded directly to the process connectors at each end.

The centre-block is brazed onto the sensor pipes from the outside acting as a mechanical low pass filter.

The sensor is available in 2 material configurations, AISI 316L or Hastelloy C22 with a wide variety of process connections.

The enclosure is made in stainless steel AISI 316L mat. no 1.4404 with a grade of encapsulation of IP66/NEMA 4.

The sensor is as standard EEx ia approved, intrinsically safe.

The sensor can be installed in horizontal or vertical position. In horizontal position the sensor is self draining.

Heating Jacket: All the sensors MASS 2100, DI 3 to DI 40, can optionally be equipped with a heating coil to avoid solidification of sensitive fluids during down-time or period between discontinuing processes. This feature gives the user an alternative to the costly electrical heating normally used, as it gives the freedom to choose either hot water, superheated steam or hot oil, to maintain a constant temperature inside the sensor.

Flow Measurement SITRANS F C

Flow sensor MASS 2100 DI 3 to DI 40

Function

The measuring principle is based on the Coriolis effect. See "System information SITRANS F C Coriolis mass flowmeters".

Integration

The sensor can be connected to all MASS 6000 transmitters for compact as well as remote installation.

All sensors are delivered with a SENSORPROM containing all information about calibration data, identity and factory pre-programming of transmitter settings.

Installation guidelines MASS 2100 DI 3 ... DI 40 (1/8" ... 1 1/2")

Installation of sensor

If the liquid is volatile or contains solid particles, vertical mounting is not recommended.

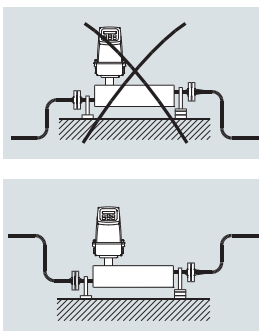
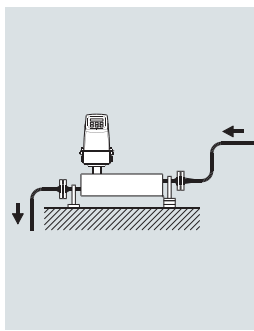
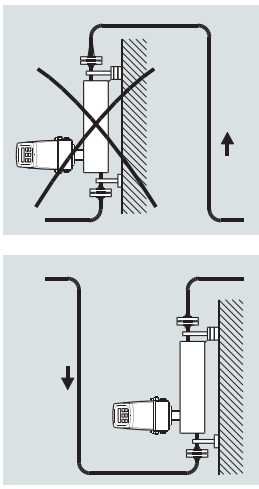
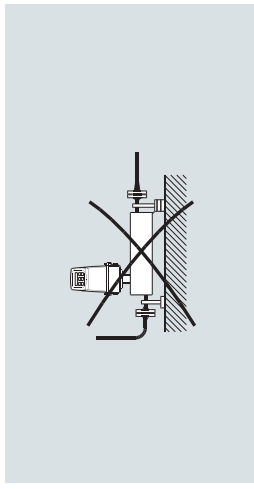
	Liquid	Gas
Horizontal		
Vertical		

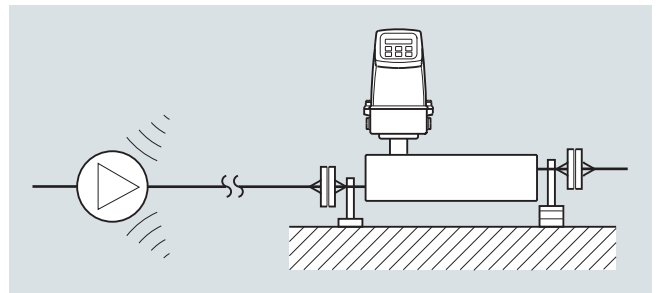

Vibration

Always locate the flowmeter as far away as possible from components that generate mechanical vibration in the piping.

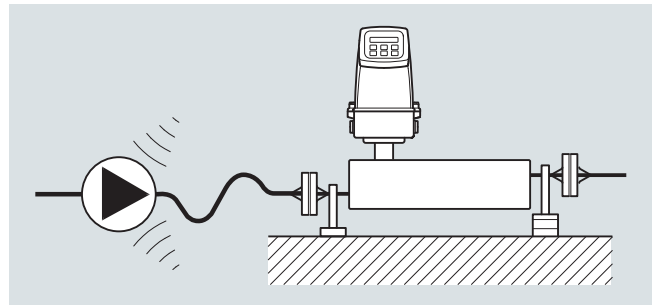

Cross talk

Cross talk between sensors mounted close to each other may disturb the measurement. To avoid cross talk never mount more than one meter on each frame and mount flexible hose connections between the sensors as shown.

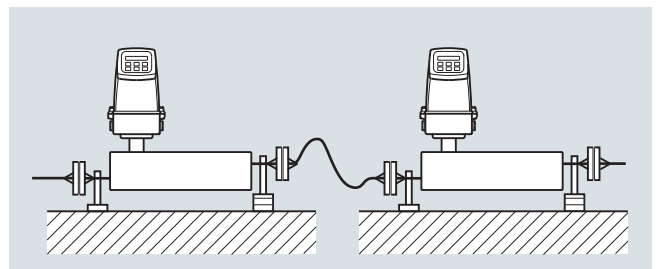

Zero point adjustment

To facilitate zero point adjustment a shut-off valve should always be mounted in connection with the sensor as a proper zero point setting is essential for a good accuracy.

Flow Measurement

SITRANS F C

Flow sensor MASS 2100 DI 3 to DI 40

Technical specifications

Versions (mm (inch))		DI 3 (1/8)	DI 6 (¼)	DI 15 (5/8)	DI 25 (1)	DI 40 (1½)
Inside pipe diameter (sensor consists of one continuous pipe)	mm (inch)	3.0 (0.12)	6.0 (0.24)	14.0 (0.55)	29.7 (1.17)	43.1 (1.70)
Pipe wall thickness	mm (inch)	0.5 (0.02)	1.0 (0.04)	1.0 (0.04)	2.0 (0.08)	2.6 (0.10)
Mass flow measuring range	kg/h (lb/h)	0 ... 250 (0 ... 550)	0 ... 1000 (0 ... 2200)	0 ... 5600 (0 ... 12345)	0 ... 25000 (0 ... 55100)	0 ... 52000 (0 ... 114600)
Density	g/cm ³ (lb/inch ³)	0 ... 2.9 (0 ... 0.10)				
Fraction e.g.	°Brix	0 ... 100				
Temperature						
Standard	°C (°F)	-50 ... +180 °C (-58 ... +356 °F)				
Liquid pressure measuring pipe¹⁾						
Stainless steel	bar (psi)	230 (3336)	265 (3844)	130 (1885)	110 (1595)	105 (1523)
Hastelloy C22	bar (psi)	350 (5076)	410 (5946)	200 (2900)	185 (2683)	not available
Materials						
Measuring pipe, flange and thread connection		Mat. no 1.4435 (AISI 316L) (Stainless steel)				not available
		Mat. no 2.4602 (Hastelloy C22)				not available
Enclosure and enclosure material						
		IP65 (NEMA 4) and mat. no 1.4404 (AISI 316L) (Stainless steel), housing is not rated for pressure containment				
Process connections²⁾						
Flange						
EN 1092-1, PN 40			DN 10	DN 15	DN 25	DN 40
ANSI B16.5, Class 150			½"	½"	1"	1½"
ANSI B16.5, Class 600 (Class 300)			½"	½"	1"	1½"
Dairy screwed connection (PN 16/25/40)³⁾						
DIN 11851			DN 10	DN 15	DN 32	DN 40
ISO 2853/BS 4825 part 4 (SS3351)			25 mm	25 mm	38 mm	51 mm
Dairy clamp connection (PN 16)³⁾						
ISO 2852/BS 4825 part 3 (SMS3016)			25 mm	25 mm	38 mm	51 mm
Thread						
ISO 228/1, PN 100		G¼" female	G¼" male	G½" male	G1" male	G2" male
ANSI/ASME B1.20.1, PN 100		¼" NPT female	¼" NPT male	½" NPT male	1" NPT male	2" NPT male
Cable connection						
		Multiple plug connection to sensor 5 x 2 x 0.35 mm ² twisted and screened in pairs, ext. Ø 12 mm				
Ex-version						
		EEx ia IIC T3-T6, DEMKO 03 ATEX 135252X				
Weight approx.	kg (lb)	4 (8.8)	8 (17.6)	12 (26.5)	48 (105.8)	70 (154.5)

¹⁾ Max. at 20 °C (68 °F), DIN 2413, DIN 17457

²⁾ Other connections to order, see "Selection and Ordering data"

³⁾ Material, mat. no. 1.4401 or corresponding

For accuracy specification see "System information SITRANS F C".

Flow sensor MASS 2100 DI 3 to DI 40

Pressure drop

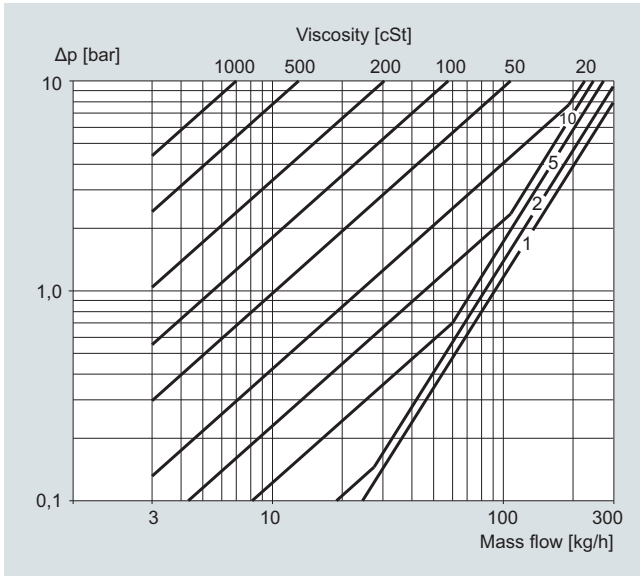

MASS 2100 DI 3 (1/8"), pressure drop for density = 1000 kg/m³

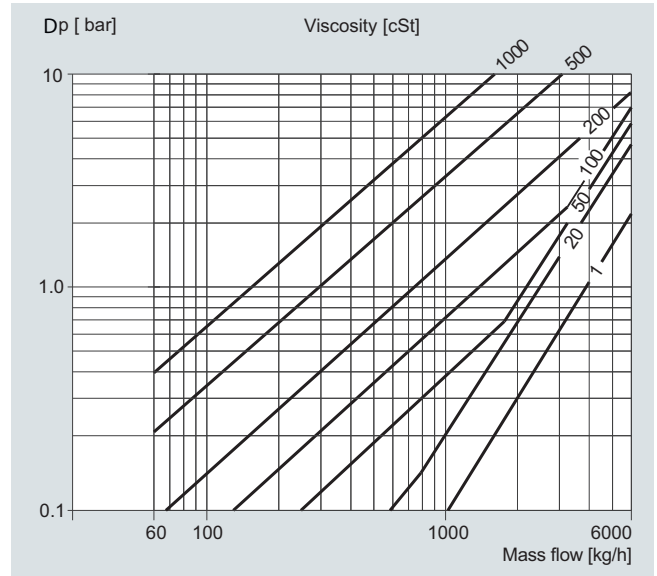

MASS 2100 DI 15 (1/2"), pressure drop for density = 1000 kg/m³

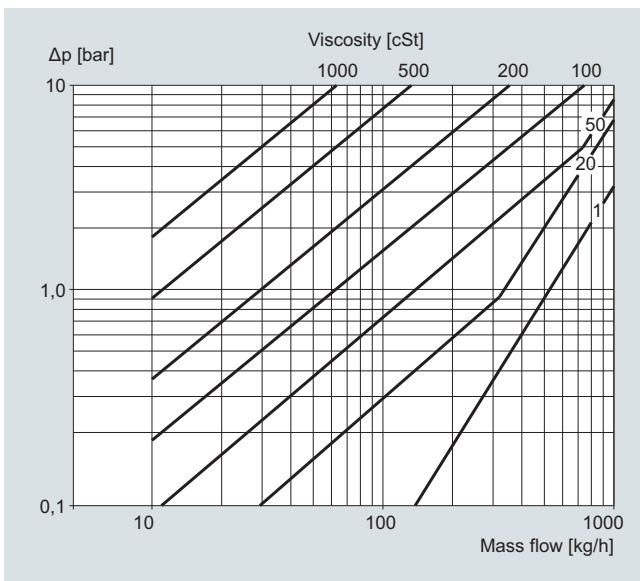

MASS 2100 DI 6 (1/4"), pressure drop for density = 1000 kg/m³

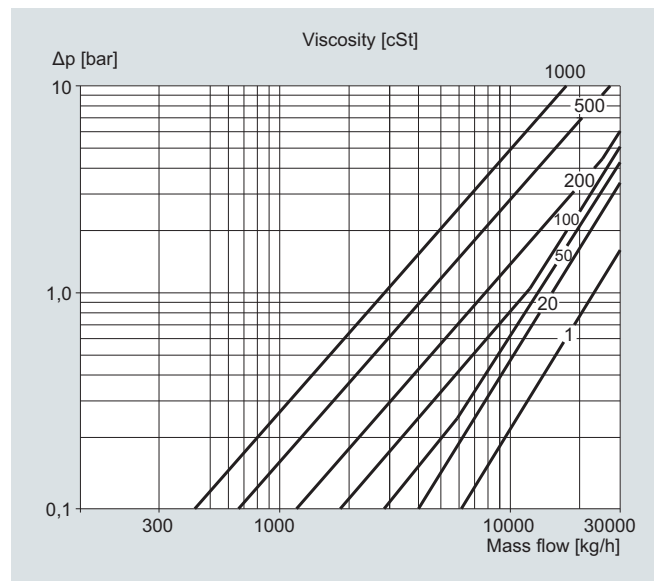

MASS 2100 DI 25 (1"), pressure drop for density = 1000 kg/m³

Flow Measurement SITRANS F C

Flow sensor MASS 2100 DI 3 to DI 40

4

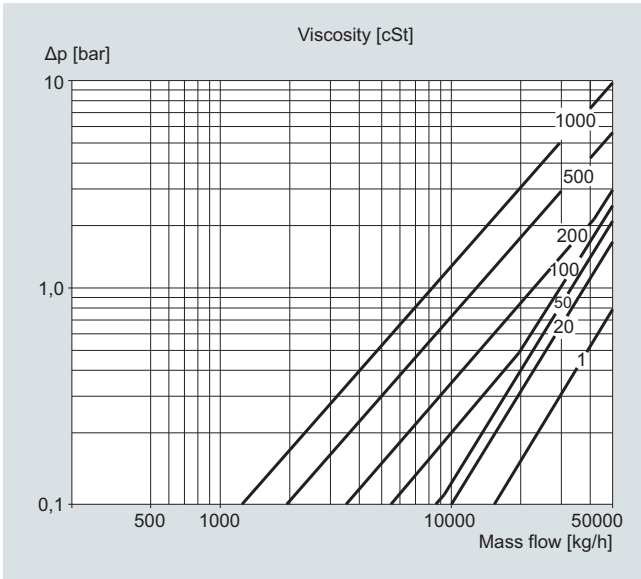

MASS 2100 DI 40 (1½"), pressure drop for density = 1000 kg/m³

Pressure-temperature curves

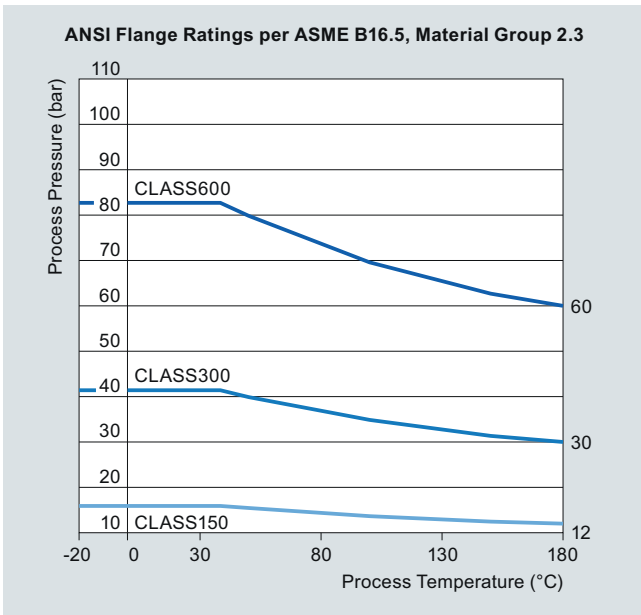

ASME flanges B16.5 stainless steel

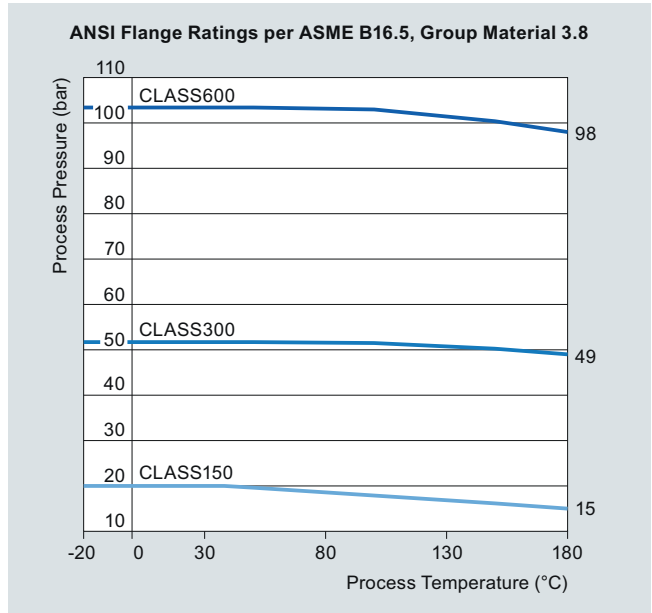

ASME flanges B16.5 Hastelloy C22

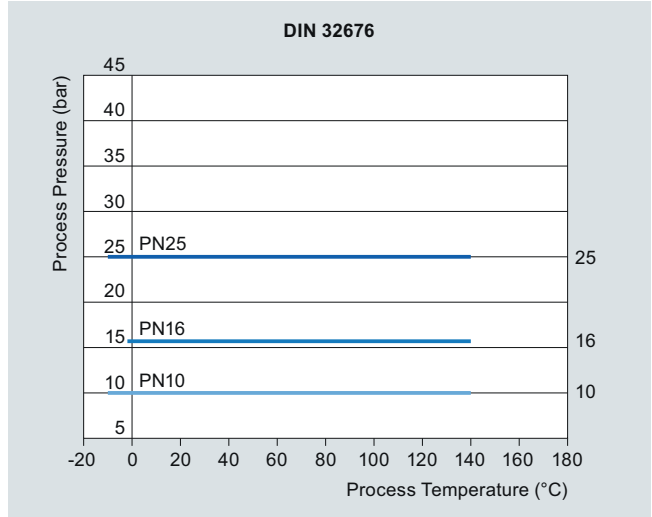

DIN 32676 flanges stainless steel (PN 10 ... PN 25)

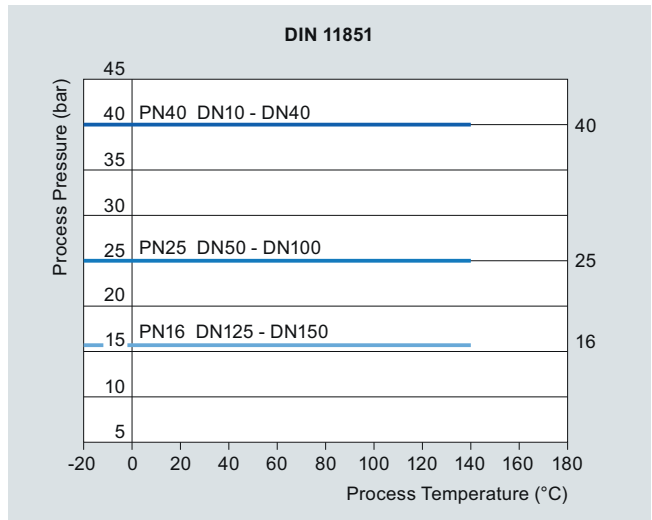

DIN 11581 flanges stainless steel (PN 25 ... PN 40)

Flow sensor MASS 2100 DI 3 to DI 40

4

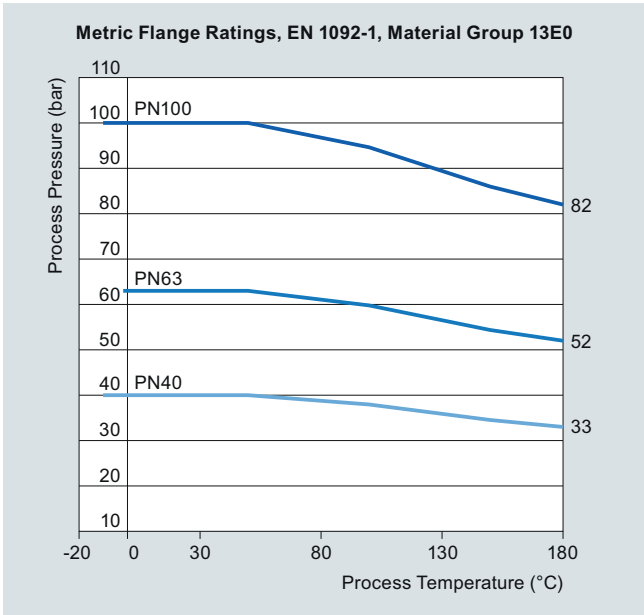

EN 1092 flanges stainless steel (PN 40 ... PN 100)

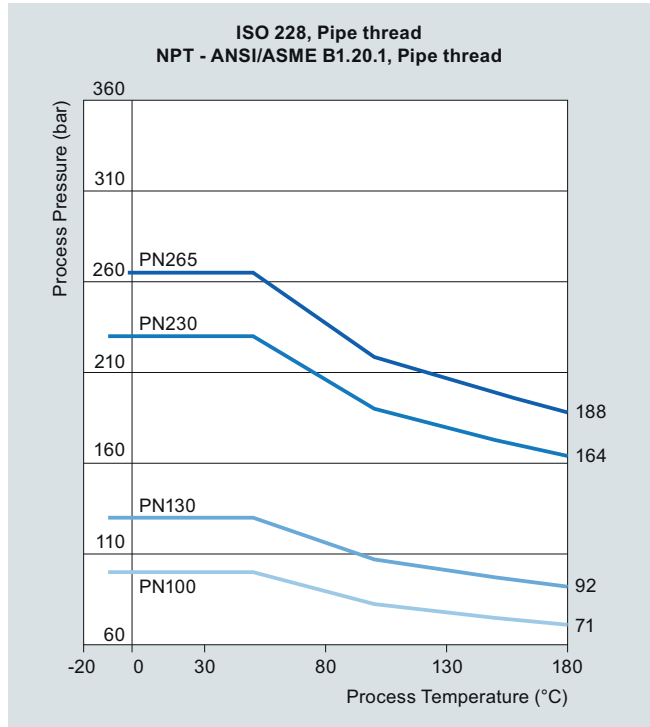

ISO 228 and NPT flanges stainless steel (PN 100 ... PN 265)

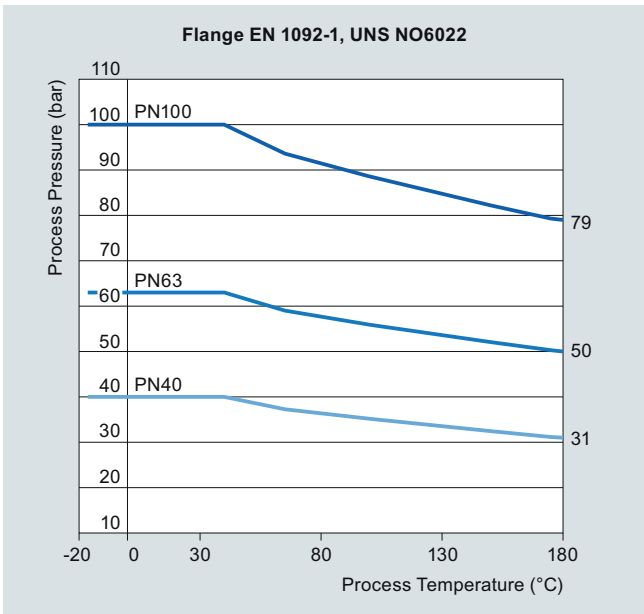

EN 1092 flanges Hastelloy C22 (PN 40 ... PN 100)

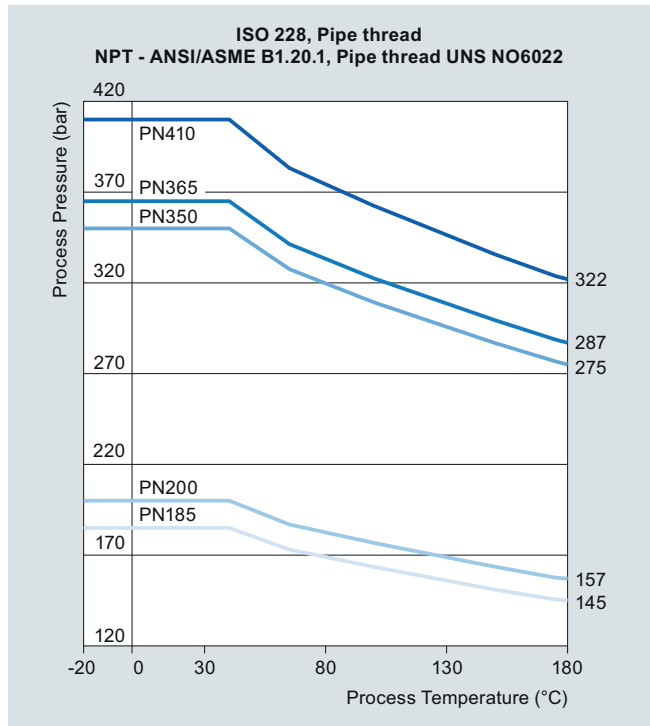

ISO 218 and NPT flanges stainless steel (PN 185 ... PN 410)

Flow Measurement

SITRANS F C

Flow sensor MASS 2100 DI 3 to DI 40

Selection and Ordering data	Order No.	Order code
SITRANS F C sensors		
MASS 2100 without heating jacket	7ME4100-	
MASS 2100 heated, DN 15 connection	7ME4200-	
MASS 2100 heated, ½ inch, ANSI B16.5 connection	7ME4210-	
Diameter		
Stainless steel mat. no. 1.4435/316L DI 3 (PN 100/PN 230)	1C	
DI 6	1D	
DI 15	1E	
DI 25	1F	
DI 40	1G	
Mat. no. 2.4602/Hastelloy C22 DI 3 (PN 100/PN 350)	2C	
DI 6	2D	
DI 15	2E	
DI 25	2F	
Pressure		
PN 16 (DI 6, DI 15, DI 25 and DI 40)	A	
PN 25 (DI 6, DI 15, DI 25 and DI 40)	B	
PN 40 (DI 6, DI 15, DI 25 and DI 40)	C	
PN 100 (DI 3, DI 6, DI 15, DI 25 and DI 40)	D	
PN 105 (DI 40, 2", 316L)	E	
PN 110 (DI 25, 1", 316L)	F	
PN 130 (DI 15, ½", 316L)	G	
PN 185 (DI 25, 1", Hastelloy C22)	J	
PN 200 (DI 15, ½", Hastelloy C22)	K	
PN 230 (DI 3, ¼", 316L)	L	
PN 265 (DI 6, ¼", 316L)	M	
PN 350 (DI 3, ¼", Hastelloy C22)	N	
PN 410 (DI 6, ¼", Hastelloy C22)	Q	
Class 150 (DI 6, DI 15, DI 25 and DI 40)	R	
Class 600 (DI 6, DI 15, DI 25 and DI 40)	S	
Process connection/flange		
Pipe thread		
G ¼"	10	
¼" NPT	11	
G ½"	12	
½" NPT	13	
G 1"	14	
1" NPT	15	
G 2"	16	
2" NPT	17	
Flange EN1092-1 Form B		
DN 10 (PN 40/PN 100)	20	
DN 15 (PN 40/PN 100)	21	
DN 25 (PN 40/PN 100)	22	
DN 40 (PN 40/PN 100)	23	
DN 50 (PN 40/PN 100)	24	
Flange ASME/ANSI B 16.5		
½" (class 150/class 600)	30	
¾" (class 150/class 600)	31	
1" (class 150/class 600)	32	
1 ½" (class 150/class 600)	33	
2" (class 150/class 600)	34	

Please also see www.siemens.com/SITRANSFordering for practical examples of ordering

Selection and Ordering data	Order No.	Order code
SITRANS F C sensors		
MASS 2100 without heating jacket	7ME4100-	
MASS 2100 heated, DN 15 connection	7ME4200-	
MASS 2100 heated, ½ inch, ANSI B16.5 connection	7ME4210-	
Dairy screwed connection DIN 11851		
DN 10 (PN 40)	40	
DN 15 (PN 40)	41	
DN 25 (PN 40)	42	
DN 32 (PN 40)	43	
DN 40 (PN 25)	44	
DN 50 (PN 25)	45	
DN 65 (PN 25)	46	
Dairy clamp connection ISO 2852 (DIN 32676)		
Cone down the sensor in order to obtain self-drainage with connectors ISO 2852		
25 mm (PN 16)	50	
38 mm (PN 16)	51	
51 mm (PN 16)	52	
Dairy screwed connection ISO 2853		
25 mm (PN 16)	60	
38 mm (PN 16)	61	
51 mm (PN 16)	62	
Configuration/calibration type		
Standard		1
Density		2
BRIX/PLATO		3
Fraction (specification required)		9
Transmitter compact mounted on sensor		
No transmitter, sensor and adapter only		A
MASS 6000, Ex d, stainless steel enclosure, 1 current, 1 freq./pulse and 1 relay output, 24 V AC/DC with EEx de [ia/ib] T3 -T6 Ex-approval		B
MASS 6000, IP67, Polyamide enclosure, cable glands M20, 1 current, 1 freq./pulse and 1 relay output, 24 V AC/DC		C
MASS 6000, IP67, Polyamide enclosure, cable glands M20, 1 current, 1 freq./pulse and 1 relay output, 115/230 V AC 50/60 Hz		D
MASS 6000, IP67, Polyamide enclosure, cable glands ½" NPT, 1 current, 1 freq./pulse and 1 relay output, 24 V AC/DC		E
MASS 6000, IP67, Polyamide enclosure, cable glands ½" NPT, 1 current, 1 freq./pulse and 1 relay output, 115/230 V AC 50/60 Hz		F
Cable		
No cable		A
5 m (16.4 ft) cable		B
10 m (32.8 ft) cable		C
25 m (82 ft) cable		D
50 m (164 ft) cable		E
75 m (246 ft) cable		F
150 m (492 ft) cable		G
Calibration/verification		
Standard calibration 3 flow x 2 points		1
Stand. calibration matched pair 3 flow x 2 points		2
Accredited calibration matched pair 5 flow x 2 points (DANAK)		3
Extended calibration customer-specified select Y60, Y61, Y62 or Y63 (see additional information)		8

Dairy MLFB example**MASS 2100**

Sensor size DI 15,
mat. no. 1.4435/316L

PN 40

DN 15 connector

Standard configuration/calibration

MASS 6000 IP67 compact mounted

No cable

Standard calibration, 3 flow x 2 points

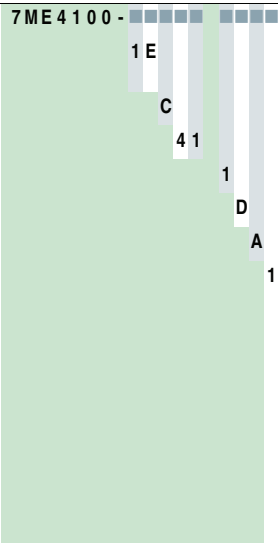
**Selection and Ordering data****Accessories**

Description	Dimension	Order No.
Mating parts for hygienic fittings DIN 11851	DN 10	FDK-085U1016
	DN 15	FDK-085U1017
Includes:	DN 25	FDK-085U1019
• 2 unions	DN 32	FDK-085U1020
• 2 mating parts (for welding in)	DN 40	FDK-085U1021
• 2 EPDM gaskets	DN 50	FDK-085U1022
	DN 65	FDK-085U1023
Mating parts for hygienic clamp ISO 2852	25 mm	FDK-085U1029
	40 mm	FDK-085U1031
Includes:	50 mm	FDK-085U1032
• 2 clamps		
• 2 mating parts		
• 2 EPDM gaskets		

Gaskets for MASS 2100

Description	Dimension	Order No.
2 EPDM gaskets with collar for mounting set DIN 11851	DN 10	FDK-085U1006
	DN 15	FDK-085U1007
	DN 25	FDK-085U1009
	DN 32	FDK-085U1010
	DN 40	FDK-085U1011
	DN 50	FDK-085U1012
	DN 65	FDK-085U1013

Spare parts

Description	Length	Order No.
Cable with multiple plug	5 m (16.4 ft)	FDK-083H3015
Standard blue cable between MASS 6000 and MASS 2100.	10 m (32.8 ft)	FDK-083H3016
5 x 2 x 0.34 mm ² twisted and screened in pairs.	25 m (82 ft)	FDK-083H3017
Temperature range -20 °C ... +110 °C (-4 °F ... +230 °F)	50 m (164 ft)	FDK-083H3018
	75 m (246 ft)	FDK-083H3054
	150 m (492 ft)	FDK-083H3055
Adapter for MASS 2100		FDK-083L8889
Multiple plug for cable mounting		FDK-083H5056
2 kB SENSORPROM unit (Sensor Serial No. and Order No. must be specified by ordering)		FDK-083H4410

Selection and Ordering data

Order code

Additional information

Please add "-Z" to Order No. and specify Order
code(s) and plain text.

Pressure testing certificate PED: 97/23/EC	C11
Material certificate EN 10204-3.1	C12
Welding certificate NDT X-ray: EN 25817/B DI 3 sensor only: NDT-Penetrant: ISO 3452	C13
Factory certificate according to EN 10204 2.2	C14
Factory certificate according to EN 10204 2.1	C15
Tag name plate, stainless steel	Y17
Tag name plate, plastic	Y18
Customer-specific transmitter setup	Y20
Customer-specified, matched pair (5 x 2)	Y60
Customer-specified calibration (5 x 2)	Y61
Customer-specified, matched pair (10 x 1)	Y62
Customer-specified calibration (10 x 1)	Y63
Cleaned for oil and grease	Y80
Special version	Y99

Operating instructions for SITRANS F C MASS 2100 DI 3 to DI 40

Description	Order No.
Operating instructions for SITRANS F C MASS 2100 DI 3 to DI 40	
• English	A5E02896535
• German	A5E03073519
• Spanish	A5E03073549
• French	A5E03073539

This device is shipped with a Quick Start guide and a CD containing
further SITRANS F literature.

All literature is also available for free at:
<http://www.siemens.com/flowdocumentation>

Flow Measurement

SITRANS F C

Flow sensor MASS 2100 DI 3 to DI 40

Dimensional drawings

MASS 2100 sensor

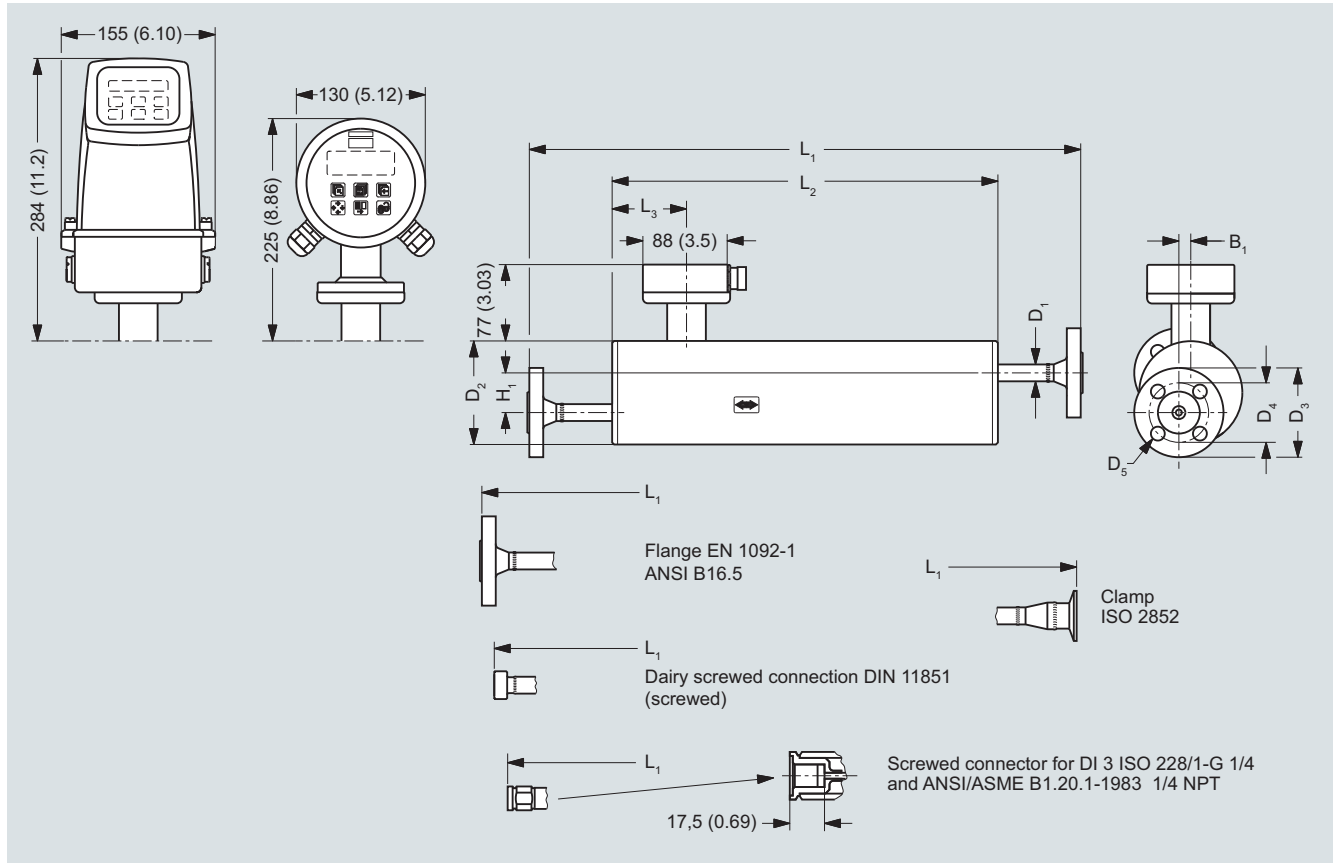

Dimension in mm (inch)

Sensor size	Connections			L1	L2	L3	H1	B1	D1	D2	D3	D4	D5
DI (inch)	Type	Pressure rating	Size	mm	mm	mm	mm	mm	mm	mm	mm	mm	mm
DI 3 (1/8)	Pipe thread ISO 228/1 - G 1/4	PN 100	1/4"	400	280	75.5	60	0	21.3	104	-	-	-
	Pipe thread ANSI/ASME B 1.20.1 - 1/4" NPT	PN 100	1/4"	400	280	75.5	60	0	21.3	104	-	-	-
DI 6 (1/4)	Flange EN 1092-1	PN 100	DN 10	580	390	62.0	40	12	17.0	104	100	70.0	14.0
	Flange EN 1092-1	PN 40	DN 10	560	390	62.0	40	12	17.0	104	90.0	60.0	14.0
	Flange ANSI B16.5	Class 150	1/2"	624	390	62.0	40	12	17.0	104	88.9	60.5	15.7
	Flange ANSI B16.5	Class 600	1/2"	608	390	62.0	40	12	17.0	104	95.3	66.5	15.7
	Screwed connection DIN 11851	PN 40	DN 10	532	390	62.0	40	12	17.0	104	-	-	-
Clamp ISO 2852	PN 16	25 mm	570	390	62.0	40	12	17.0	104	-	-	-	
DI 15 (1/2)	Flange EN 1092-1	PN 100	DN 15	634	444	75.5	44	20	21.3	129	105	75.0	14.0
	Flange EN 1092-1	PN 40	DN 15	620	444	75.5	44	20	21.3	129	95.0	65.0	14.0
	Flange ANSI B16.5	Class 150	1/2"	639	444	75.5	44	20	21.3	129	88.9	60.5	15.7
	Flange ANSI B16.5	Class 600	1/2"	660	444	75.5	44	20	21.3	129	95.3	66.5	15.7
	Screwed connection DIN 11851	PN 40	DN 15	586	444	75.5	44	20	21.3	129	-	-	-
Clamp ISO 2852	PN 16	25 mm	624	444	75.5	44	20	21.3	129	-	-	-	
DI 25 (1)	Flange EN 1092-1	PN 100	DN 25	970	700	75.5	126	25	33.7	219	140.0	100.0	18.0
	Flange EN 1092-1	PN 40	DN 25	934	700	75.5	126	25	33.7	219	115.0	85.0	14.0
	Flange ANSI B16.5	Class 150	1"	967	700	75.5	126	25	33.7	219	108.0	79.2	15.7
	Flange ANSI B16.5	Class 600	1"	992	700	75.5	126	25	33.7	219	124.0	88.9	19.1
	Screwed connection DIN 11851	PN 40	DN 32	922	700	75.5	126	25	33.7	219	-	-	-
Clamp ISO 2852	PN 16	38 mm	940	700	75.5	126	25	33.7	219	-	-	-	
DI 40 (1 1/2)	Flange EN 1092-1	PN 100	DN 40	1100	850	75.5	180	0	48.3	273	170.0	125.0	22.0
	Flange EN 1092-1	PN 40	DN 40	1063	850	75.5	180	0	48.3	273	150.0	110.0	18.0
	Flange ANSI B16.5	Class 150	1 1/2"	1100	850	75.5	180	0	48.3	273	127.0	98.6	15.7
	Flange ANSI B16.5	Class 600	1 1/2"	1128	850	75.5	180	0	48.3	273	155.4	114.3	22.4
	Screwed connection DIN 11851	PN 25	DN 50	1090	850	75.5	180	0	48.3	273	-	-	-
Clamp ISO 2852	PN 25	51 mm	1062	850	75.5	180	0	48.3	273	-	-	-	

Sensor size	Connections			L1	L2	L3	H1	B1	D1	D2	D3	D4	D5
DI (inch)	Type	Pressure rating	Size	inch	inch	inch	inch	inch	inch	inch	inch	inch	inch
DI 3 (1/8)	Pipe thread ISO 228/1 - G¼	PN 100	¼"	15.75	11.02	2.97	2.36	0	0.84	4.09	-	-	-
	Pipe thread ANSI/ASME B 1.20.1 - ¼" NPT	PN 100	¼"	15.75	11.02	2.97	2.36	0	0.84	4.09	-	-	-
DI 6 (¼)	Flange EN 1092-1	PN 100	DN 10	22.83	15.35	2.44	1.57	0.47	0.67	4.09	3.94	2.76	0.55
	Flange EN 1092-1	PN 40	DN 10	22.05	15.35	2.44	1.57	0.47	0.67	4.09	3.54	2.36	0.55
	Flange ANSI B16.5	Class 150	½"	24.57	15.35	2.44	1.57	0.47	0.67	4.09	3.5	2.38	0.62
	Flange ANSI B16.5	Class 600	½"	23.94	15.35	2.44	1.57	0.47	0.67	4.09	3.75	2.62	0.62
	Screwed connection DIN 11851	PN 40	DN 10	20.94	15.35	2.44	1.57	0.47	0.67	4.09	-	-	-
	Clamp ISO 2852	PN 16	25 mm	22.44	15.35	2.44	1.57	0.47	0.67	4.09	-	-	-
DI 15 (½)	Flange EN 1092-1	PN 100	DN 15	24.96	17.48	2.97	1.73	0.79	0.84	5.08	2.95	4.13	0.55
	Flange EN 1092-1	PN 40	DN 15	24.41	17.48	2.97	1.73	0.79	0.84	5.08	3.74	2.56	0.55
	Flange ANSI B16.5	Class 150	½"	25.16	17.48	2.97	1.73	0.79	0.84	5.08	3.5	2.38	0.62
	Flange ANSI B16.5	Class 600	½"	25.98	17.48	2.97	1.73	0.79	0.84	5.08	3.75	2.62	0.62
	Screwed connection DIN 11851	PN 40	DN 15	23.07	17.48	2.97	1.73	0.79	0.84	5.08	-	-	-
	Clamp ISO 2852	PN 16	25 mm	24.57	17.48	2.97	1.73	0.79	0.84	5.08	-	-	-
DI 25 (1)	Flange EN 1092-1	PN 100	DN 25	38.19	27.56	2.97	4.96	0.98	1.33	8.62	3.94	5.51	0.71
	Flange EN 1092-1	PN 40	DN 25	36.77	27.56	2.97	4.96	0.98	1.33	8.62	4.53	3.35	0.55
	Flange ANSI B16.5	Class 150	1"	38.07	27.56	2.97	4.96	0.98	1.33	8.62	4.25	3.12	0.62
	Flange ANSI B16.5	Class 600	1"	39.06	27.56	2.97	4.96	0.98	1.33	8.62	4.88	3.50	0.75
	Screwed connection DIN 11851	PN 40	DN 32	36.30	27.56	2.97	4.96	0.98	1.33	8.62	-	-	-
	Clamp ISO 2852	PN 16	38 mm	37.01	27.56	2.97	4.96	0.98	1.33	8.62	-	-	-
DI 40 (1½)	Flange EN 1092-1	PN 100	DN 40	43.31	33.46	2.97	7.09	0	1.9	10.75	4.92	6.69	0.87
	Flange EN 1092-1	PN 40	DN 40	41.85	33.46	2.97	7.09	0	1.9	10.75	5.91	4.33	0.71
	Flange ANSI B16.5	Class 150	1½"	43.31	33.46	2.97	7.09	0	1.9	10.75	5	3.88	0.62
	Flange ANSI B16.5	Class 600	1½"	44.41	33.46	2.97	7.09	0	1.9	10.75	6.12	4.50	0.88
	Screwed connection DIN 11851	PN 25	DN 50	42.91	33.46	2.97	7.09	0	1.9	10.75	-	-	-
	Clamp ISO 2852	PN 25	51 mm	41.81	33.46	2.97	7.09	0	1.9	10.75	-	-	-

For not listed variants please contact product support.

Flow Measurement

SITRANS F C

Flow sensor MASS 2100 DI 3 to DI 40

MASS 2100 sensor with "heating jacket"

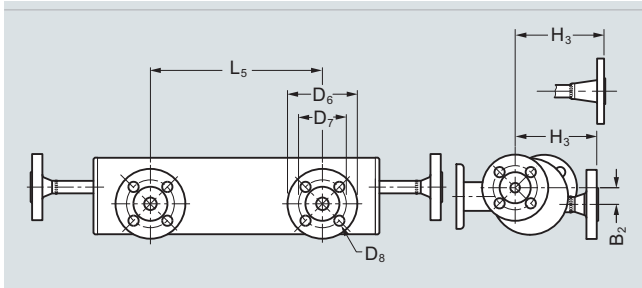

Dimensions in mm (inch)

Sensor size	Connections heated			L5	H3	B2	D6	D7	D8
DI (inch)	Type	Pressure rating	Size	mm (inch)	mm (inch)	mm (inch)	mm (inch)	mm (inch)	mm (inch)
DI 3 (1/8)	EN 1092-1	PN 40	DN 15	234 (9.21)	122 (4.8)	22 (0.87)	95 (3.74)	65.0 (2.56)	14.0 (0.55)
	ANSI B16.5	Class 150	½"	234 (9.21)	131.6 (5.18)	22 (0.87)	88.9 (3.5)	60.5 (2.38)	15.7 (0.62)
DI 6 (¼)	EN 1092-1	PN 40	DN 15	234 (9.21)	112 (4.41)	22.7 (0.89)	95 (3.74)	65.0 (2.56)	14.0 (0.55)
	ANSI B16.5	Class 150	½"	234 (9.21)	121.6 (4.79)	22.7 (0.89)	88.9 (3.5)	60.5 (2.38)	15.7 (0.62)
DI 15 (½)	EN 1092-1	PN 40	DN 15	234 (9.21)	126.5 (4.98)	31.5 (1.24)	95 (3.74)	65.0 (2.56)	14.0 (0.55)
	ANSI B16.5	Class 150	½"	234 (9.21)	136.1 (5.36)	31.5 (1.24)	88.9 (3.5)	60.5 (2.38)	15.7 (0.62)
DI 25 (1)	EN 1092-1	PN 40	DN 15	420 (16.54)	213.6 (8.41)	60 (2.36)	95 (3.74)	65.0 (2.56)	14.0 (0.55)
	ANSI B16.5	Class 150	½"	420 (16.54)	223.2 (8.79)	60 (2.36)	88.9 (3.5)	60.5 (2.38)	15.7 (0.62)
DI 40 (1½)	EN 1092-1	PN 40	DN 15	500 (19.68)	267.5 (10.53)	43 (1.69)	95 (3.74)	65.0 (2.56)	14.0 (0.55)
	ANSI B16.5	Class 150	½"	500 (19.68)	277.1 (10.91)	43 (1.69)	88.9 (3.5)	60.5 (2.38)	15.7 (0.62)

MASS 2100 and MASS 6000 Ex d compact version

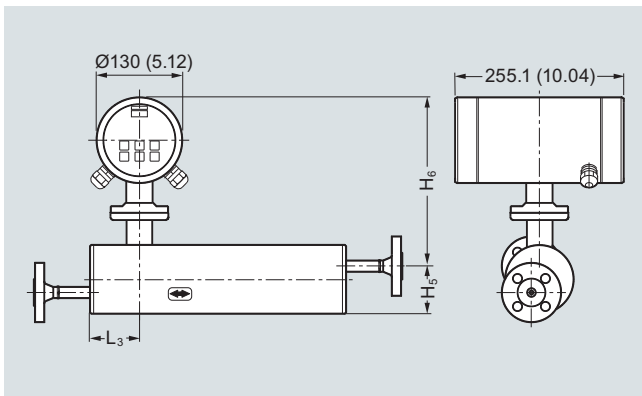

Dimensions in mm (inch)

Sensor size	L ₃	H ₅	H ₆	H ₅ + H ₆
[DI (inch)]	[mm (inch)]	[mm (inch)]	[mm (inch)]	[mm (inch)]
3 (1/8)	75 (2.95)	82 (3.23)	247 (9.72)	329 (12.95)
6 (¼)	62 (2.44)	72 (2.83)	257 (10.12)	329 (12.95)
15 (½)	75 (2.95)	87 (3.43)	267 (10.51)	354 (13.94)
25 (1)	75 (2.95)	173 (6.81)	271 (10.67)	444 (17.48)
40 (1½)	75 (2.95)	227 (8.94)	271 (10.67)	498 (19.61)

MASS 2100 and MASS 6000 IP67 compact version

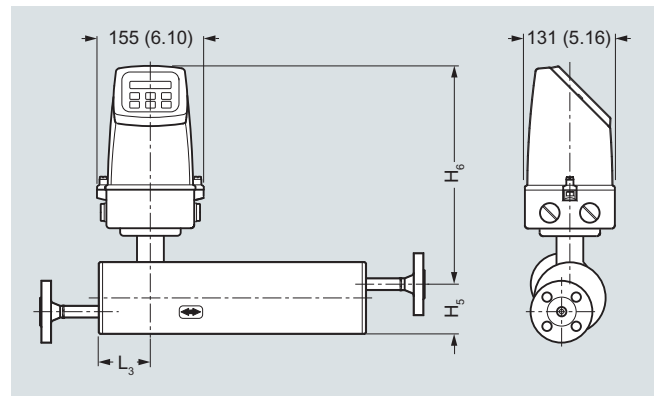

Dimensions in mm (inch)

Sensor size	L ₃	H ₅	H ₆	H ₅ + H ₆
[DI (inch)]	[mm (inch)]	[mm (inch)]	[mm (inch)]	[mm (inch)]
3 (1/8)	75 (2.95)	82 (3.23)	306 (12.04)	388 (15.28)
6 (¼)	62 (2.44)	72 (2.83)	316 (12.44)	388 (15.28)
15 (½)	75 (2.95)	87 (3.43)	326 (12.83)	413 (16.26)
25 (1)	75 (2.95)	173 (6.81)	330 (13.00)	503 (19.80)
40 (1½)	75 (2.95)	227 (8.94)	330 (13.00)	557 (21.93)